





menred<sup>®</sup>

User Manual

Wall Mounted Ventilator  
(IT90)

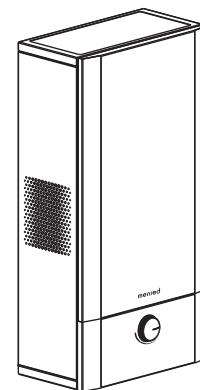

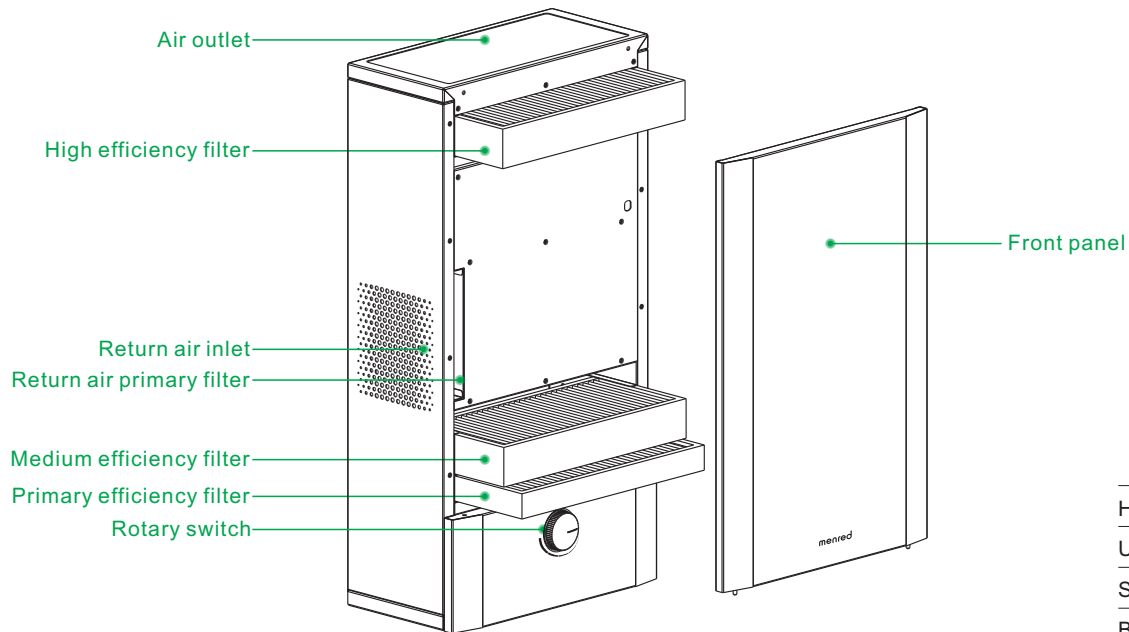

### Packing list

	Unit(pcs)
Host	1
User Manual	1
Serial number	2
Bar code	2
Certificate of quality	1
Screws package	1
Wall pipe	2

## Attention

1. In order to use the ventilation equipment safely and reasonably, users and installers must read the instruction manual carefully.
2. MENRED ventilation equipment must be installed by professional technicians.
3. If users install the product by themselves, or by their own installation material, MENRED will not be responsible for any consequence or loss (such as pipe leakage, machine crash, abnormal operation or use because of improper installation, damage etc.).
4. After the product is installed, users should check and maintain it often according to the service condition. Any abnormal condition, please contact after-sales service department of local installation company to repair and make sure the product can operate normally, safely and reliably.
5. Filters should be checked and replaced regularly. Users can contact local installation company to check and replace.  
The recommended inspection period is 6 months.
6. Please cut off power before maintenance or repairing the product. Non-professionals should not adjust and repair products.
7. If the power cord is damaged, in order to avoid danger, it must be replaced by the professional technicians.
8. The equipment uses fixed wiring connection mode. Connect a switch with contact above 3mm space when installation.
9. After installation, users should test the equipment immediately to check if the product get damaged or not during the transportation.
10. The power outlet must have a reliable ground connection. It is prohibited using the outlet without a reliable ground connection.

menred central ventilator system

Dimension

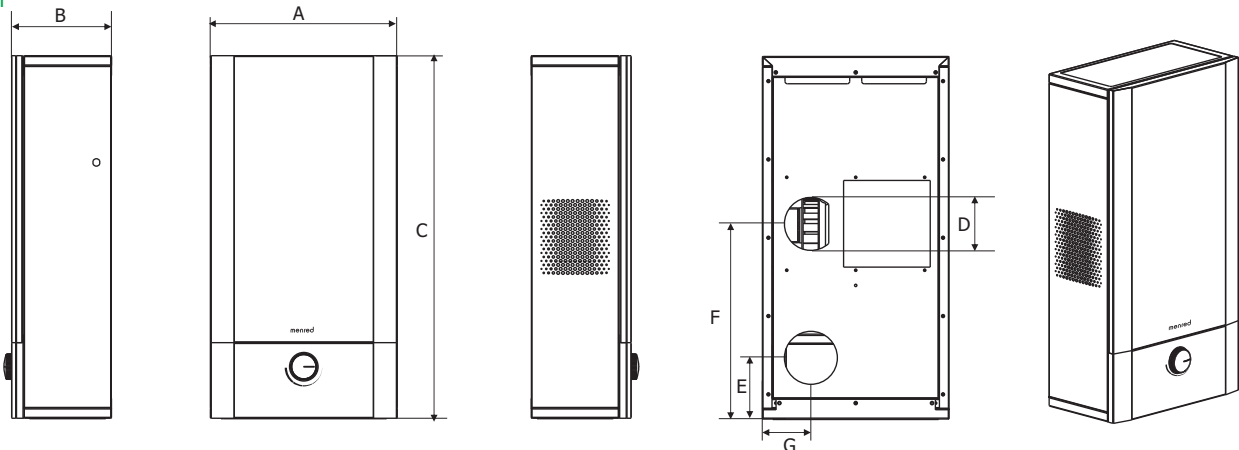

Unit(mm)

Outline dimension							
	A	B	C	D	E	F	G
IT90	385	205	750	110	130	405	100

Performance parameter

Model	Power(V/Hz)	Air volume(m <sup>3</sup> /h)	Power(W)	Noise(dB(A))	Weight(kg)
IT90	220/50	90	30	37	23

Note: if the design changes, the above data will be modified without prior notice. Please refer to the product for the exact size.

### Installation diagram

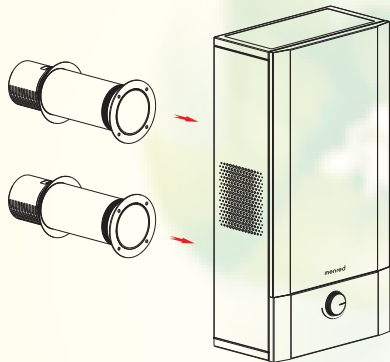

1. Press the installation board on the wall and draw the positions of installation holes and screw holes.
2. Use the drill to punch the hole in the marked position by leaning down 3°. The hole size should be greater than Ø120 but less than Ø130. Then punch the screw holes by the drill with diameter Ø8 and put expansion screws.
3. Fix the mounting board on the wall by tapping screws.
4. Insert the wall pipe into the wall and the outdoor air vent should be installed downwards. Tightening the fixing part clockwise, put foaming agent in the four holes and cut off the redundant wall pipes.
5. Hang the machine on the mounting board and fix it by screws.

### Repair and maintenance

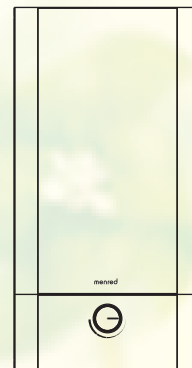

Make sure that there is no obstacle within 50mm in the right side of the machine when repairing and maintaining.

### Filter element change

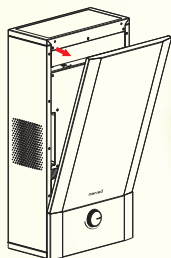

1. Open the front panel as shown in the figure.

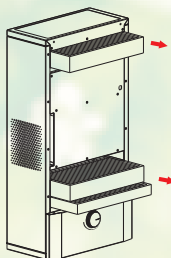

2. Take out the filter elements in the direction of the figure.

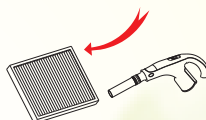

3. Clean the dust in the filter by the vacuum cleaner or change the filter element.

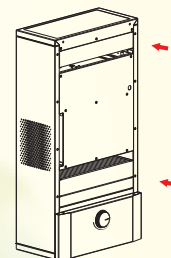

4. Put the clean filter elements into the corresponding slots and close the front panel.

### Filter function introduction

Filter position	Model	Size( mm )	Class	Maintenance period(month)	Maintenance method
Primary efficiency filter	F167	347x165x35	G4	6	Change
Medium efficiency filter	F166	347x165x50	F9	6	Change
High efficiency filter	F165	347x165x55	H11	6	Change
Return air primary filter	F168	180x165x16	G4	6	Change

Primary efficiency filter: effectively block particles greater than PM10.

Medium efficiency filter: intercept particles with diameter above 2.5um, efficiently protect filters and prolong the high efficiency filter working life.

High efficiency filter: efficiently filter PM2.5. Large dust capacity and low wind resistance.

### Rotary switch



Figure 1



Figure 2



Figure 3



Figure 4



Figure 5

- When the switch is in the figure 1 position, the ventilator is in closed state.
- When the switch is in the figure 2 position, the ventilator is in gear 1 and the air volume is 30m<sup>3</sup>/h.
- When the switch is in the figure 3 position, the ventilator is in gear 2 and the air volume is 50m<sup>3</sup>/h.
- When the switch is in the figure 4 position, the ventilator is in gear 3 and the air volume is 70m<sup>3</sup>/h.
- When the switch is in the figure 5 position, the ventilator is in gear 4 and the air volume is 90m<sup>3</sup>/h.

### Wiring diagram

